



**John
BOOS**
Since 1887

ITEM #: _____ QTY: _____
 MODEL #: _____
 PROJECT NAME: _____

071117

3601 S. Banker St. Effingham, IL 62401 • P.O. BOX 609 • Ph: (888) 431-2667 • Fax: (800) 433-2667

"FBLG" STAINLESS STEEL TOP WORK TABLES



18GA TOP AND GALV LEGS AND ADJUSTABLE UNDERSHELF

BUDGET E-SERIES

FEATURES:

- 18 GAUGE STAINLESS STEEL TOP
- TYPE 430 STAINLESS STEEL WITH SATIN FINISH
- TOP IS SOUND DEADENED
- REINFORCED WITH 1"X2" CHANNEL RUNNING ENTIRE LENGTH OF TABLE
- 1-1/2" STALLION EDGE ON FRONT AND REAR WITH SIDE EDGES 90 DEGREE BEND DOWN FOR TABLE LINE-UP
- GALVANIZED BASE AND ADJUSTABLE UNDERSHELF
- ADJUSTABLE BULLET FEET
- SHIPPED KNOCKED-DOWN, EASY-TO-ASSEMBLE
- NSF AND CSA CERTIFIED



FBLG4830

CONSTRUCTION:

- TOP: STAINLESS STEEL TOPS ARE TIG WELDED, EXPOSED WELDS ARE POLISHED TO MATCH ADJACENT SURFACE.

MATERIAL:

- TOP: 18 GAUGE STAINLESS STEEL TYPE 430 STAINLESS STEEL WITH SATIN FINISH
- SHELF: 18 GAUGE GALVANIZED STEEL
- LEGS: 1-5/8" ROUND O.D. 16 GAUGE TUBULAR GALVANIZED STEEL
- GUSSETS: GALVANIZED STEEL
- FEET: 1" ADJUSTABLE PLASTIC BULLET FEET



ADJUSTABLE SHELF

18 GAUGE TOP W/ ADJUSTABLE UNDERSHELF

18" WIDE	QTY	24" WIDE	QTY	30" WIDE	QTY
-		FBLG2424		-	
-		FBLG3024		FBLG3030	
FBLG3618		FBLG3624		FBLG3630	
FBLG4818		FBLG4824		FBLG4830	
FBLG6018		FBLG6024		FBLG6030	
FBLG7218		FBLG7224		FBLG7230	
-		FBLG8424		FBLG8430	
FBLG9618		FBLG9624		FBLG9630	

DETAILED SPECIFICATIONS

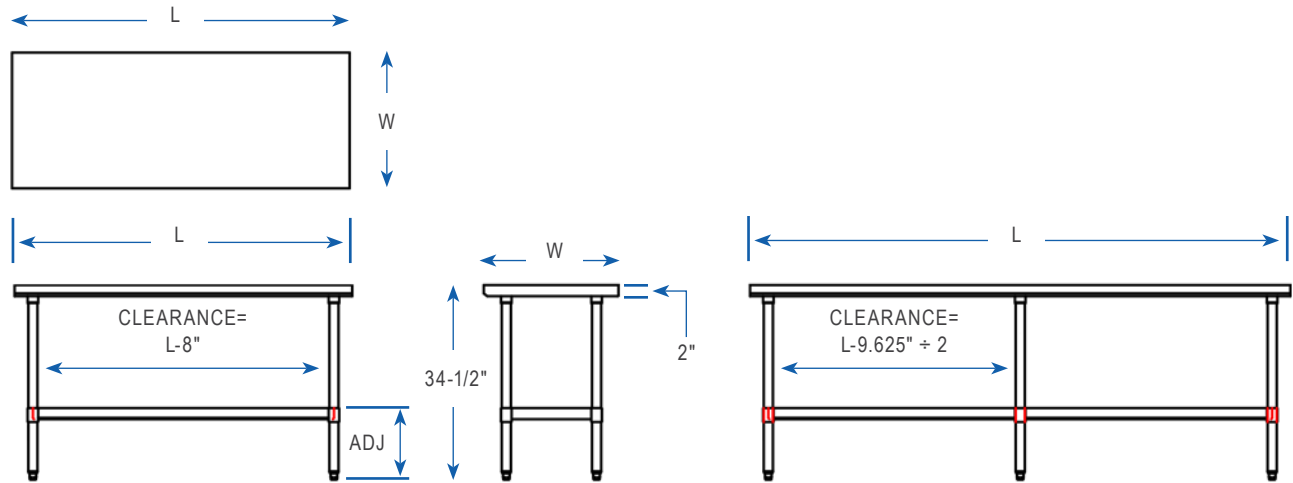

- UNITS 7 FT. AND LARGER ARE FURNISHED WITH SIX LEGS.
- FINISHED SIZE OF UNDERSHELF.
SHELF LENGTH = LENGTH MINUS 4.875"
SHELF WIDTH = WIDTH MINUS 4.25"

18 GAUGE TOP W/ ADJUSTABLE UNDERSHELF

LENGTH	18" WIDE	WT. (LBS)	24" WIDE	WT. (LBS)	30" WIDE	WT. (LBS)
24"	-	-	FBLG2424	44	-	-
30"	-	-	FBLG3024	48	FBLG3030	50
36"	FBLG3618	40	FBLG3624	50	FBLG3630	56
48"	FBLG4818	56	FBLG4824	64	FBLG4830	69
60"	FBLG6018	66	FBLG6024	71	FBLG6030	82
72"	FBLG7218	77	FBLG7224	83	FBLG7230	94
84"	-	-	FBLG8424	103	FBLG8430	116
96"	FBLG9618	98	FBLG9624	114	FBLG9630	128

SOME UNITS SHIP UNASSEMBLED FOR REDUCED SHIPPING COST. ALL DIMENSIONS ARE TYPICAL. TOLERANCE +/- .500"
John Boos & Co. is constantly engaged in a program of improving products and therefore reserves the right to change specifications without prior notice.

